

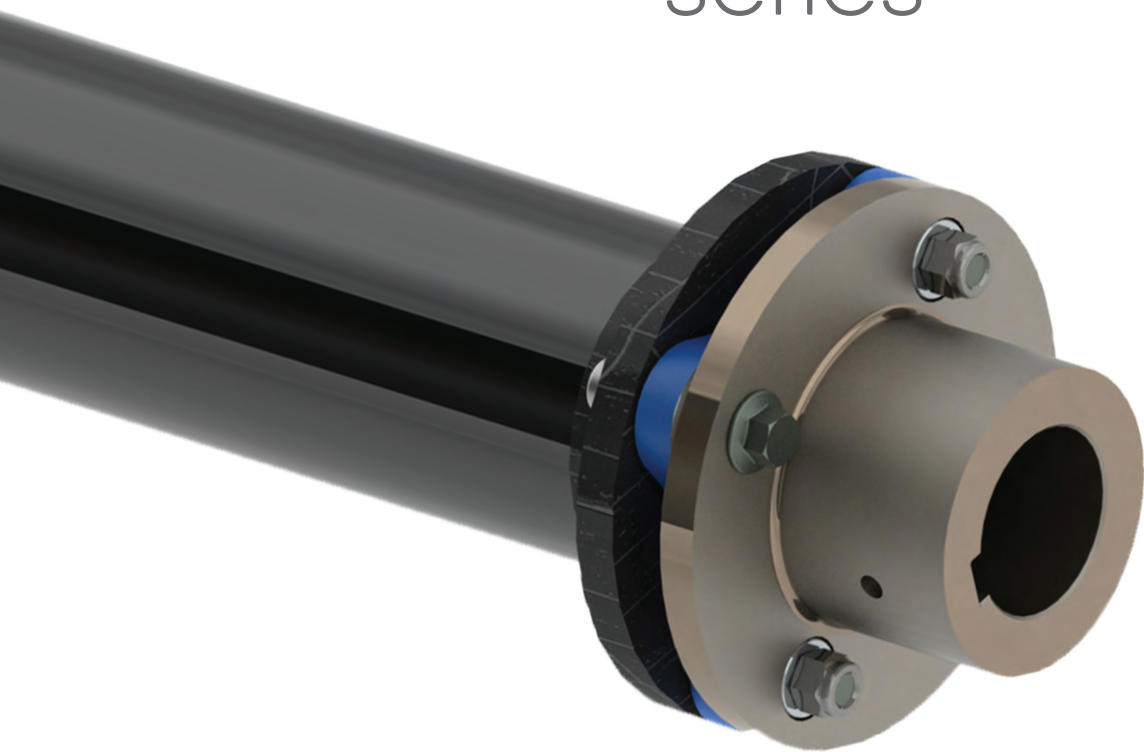

ESCODISC FIL series

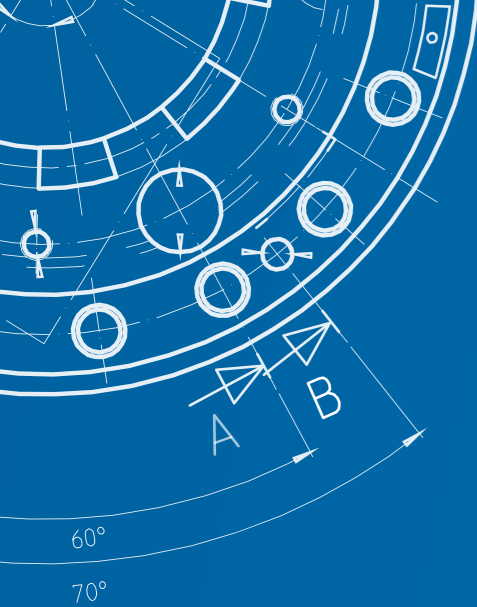

EXPERTISE DRIVEN | CUSTOMER FOCUSED | SUSTAINABLE THINKERS



INDEX

We connect the world.....	4-5
The right solution for your application.....	6-7
Why ESCODISC FIL?.....	8-9
How to select the right coupling.....	10-11
Technical data.....	12-13
Application data sheet.....	14
Equivalence chart.....	15
Much more than products.....	16-17
Global footprint.....	18-19
Catalogues and brochures.....	20
ESCO worldwide.....	21
Product range.....	22-23





We connect the world

We are a 75 years old family-owned company specialized in designing and manufacturing high-quality custom-made power transmission products.

Because we believe each transmission challenge is different, we create much more than off-the shelf products: we work hand in hand with our customers to develop the coupling solutions that best fit their specific needs.

Superior product quality is what guarantees our customers' success, it is what enables us to cherish long term partnerships with them. The ESCO quality has been worldly renown for decades and we work tirelessly to raise these standards even further.

We strive to be a significant contributor to the development of effective and clean industrial, transportation and energy supply applications. We want our couplings to power a more sustainable world. We strongly believe that both the future of our economy and the best guarantee for long term return lie in sustainable development. And we want to do our part.

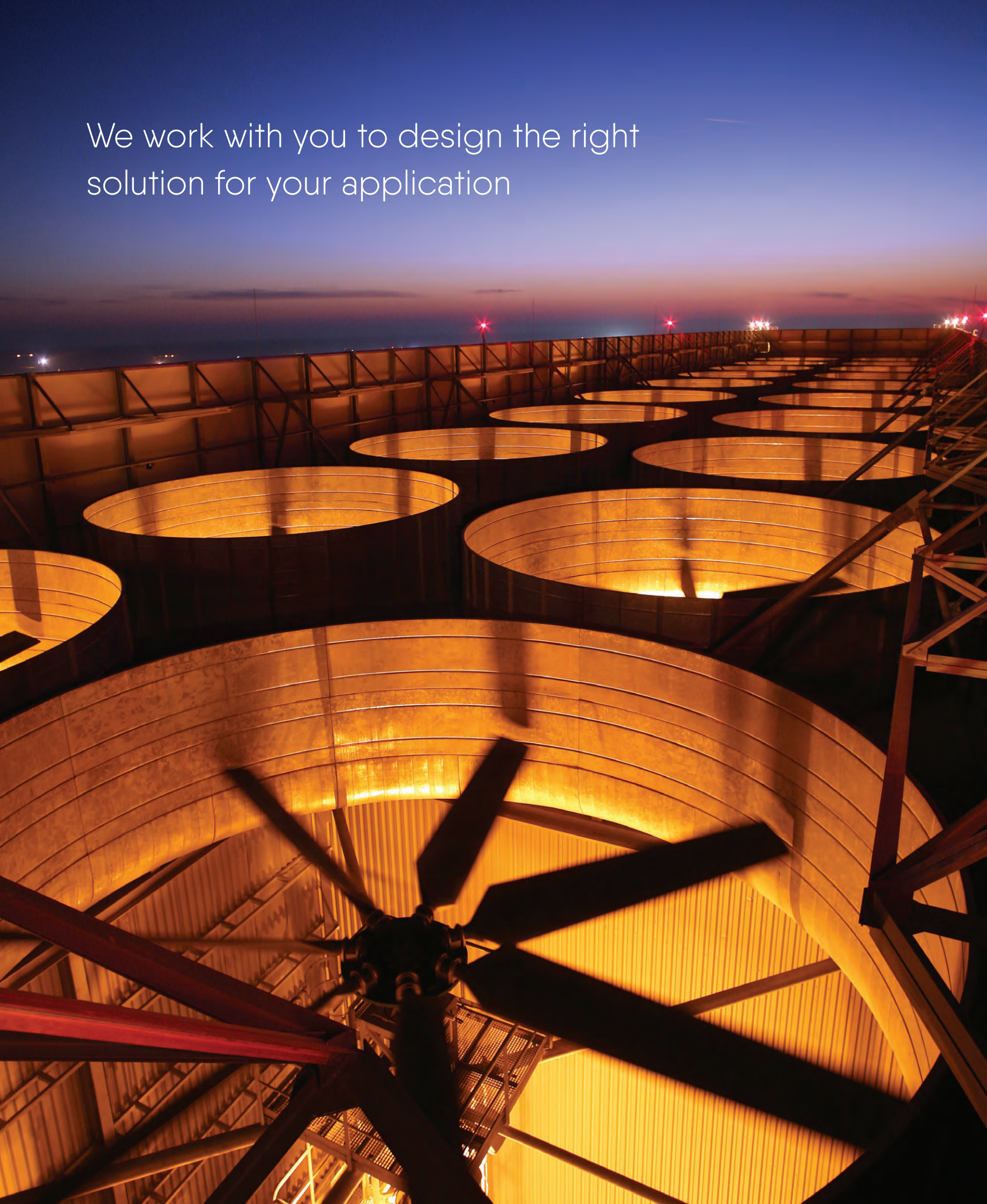

We work with you to design the right solution for your application

Extreme humidity, aggressive chemicals and minerals, important vibrations, these are only a few of the many factors that contribute to the harsh environment in which wet cooling towers operate.

Since consistent heat processing is a critical operation of many power and industrial plants, cooling towers need to be able to run continuously, without failure. Furthermore, maintenance operations should be as short and seamless as possible to minimize costly production down time.

Minimizing the life cycle cost of the installation requires careful attention when selecting the elements of the driveline. A high quality coupling will make a difference between an efficient, cost effective transmission, and a poorly optimized one.

This is where ESCO can help you. We have been helping our customers by designing high-quality tailor made couplings for more than 40 years:

- **Quality is our motto, our core competency:** ESCO products are amongst the most reliable in the market; so much so that the main hurdle in our capacity to innovate is the lack of market feedback: our couplings just keep running without issues.
- **Low lifecycle cost might well be the biggest challenge for ESCO to tackle, but we do work tirelessly to optimize the life time value of our couplings:** fair initial price, smaller footprint (space and weight), longer design life, lubrication-free alternatives, extended maintenance steps...
- **Service is an important part of our business:** to best serve your needs, you can count on our experienced

team and advanced testing capability. We are more than happy to assist in performing field interventions, maintenance and repair.

ESCO specializes in the design of custom made couplings. If you cannot find a solution that fits your needs, please contact us: we will work hard to engineer the coupling that fits your application specifications.

ESCODISC FIL series

Why ESCODISC FIL?

The ESCOFIL is a state-of-the-art disc-type flexible coupling designed for extended life and built out of advanced composite material that confer unparalleled light weight, high strength, corrosion and ultra-violet resistance to the coupling.

The ESCOFIL coupling has been designed with the customer's interest in mind and it provides significant benefits over alternative transmission solutions.

Ease of installation

- Advanced composite materials offer high resistance for only 25% of the weight of steel. The coupling does not require the use of a crane to be mounted, which makes for very convenient installation and maintenance processes.
- The flexible elements have high misalignment capacity which facilitates assembly of the coupling on the installation.
- The flexible elements are unitized: no washers nor any other hardware to mess with during installation or maintenance.

Extended life and low cost of ownership

- The ESCOFIL coupling has been designed to offer superior strength and endurance: components are dimensioned for infinite life with high resistance against corrosion.
- Lubrication-free couplings such as the ESCOFIL greatly reduce the need for lengthy maintenance which in turn lowers costly production downtime for the installation.
- Because of its light weight, the coupling does not require intermediate bearing support, which improves cost of ownership for the end-user.

Strong influence on installation life extension

- The highly advanced composite materials that constitute the ESCOFIL coupling confer multiple features (e.g. light weight, low coefficient of thermal expansion) that help reduce vibrations and the load on bearings by up to 80%.

ESCODISC FIL series

DFCT

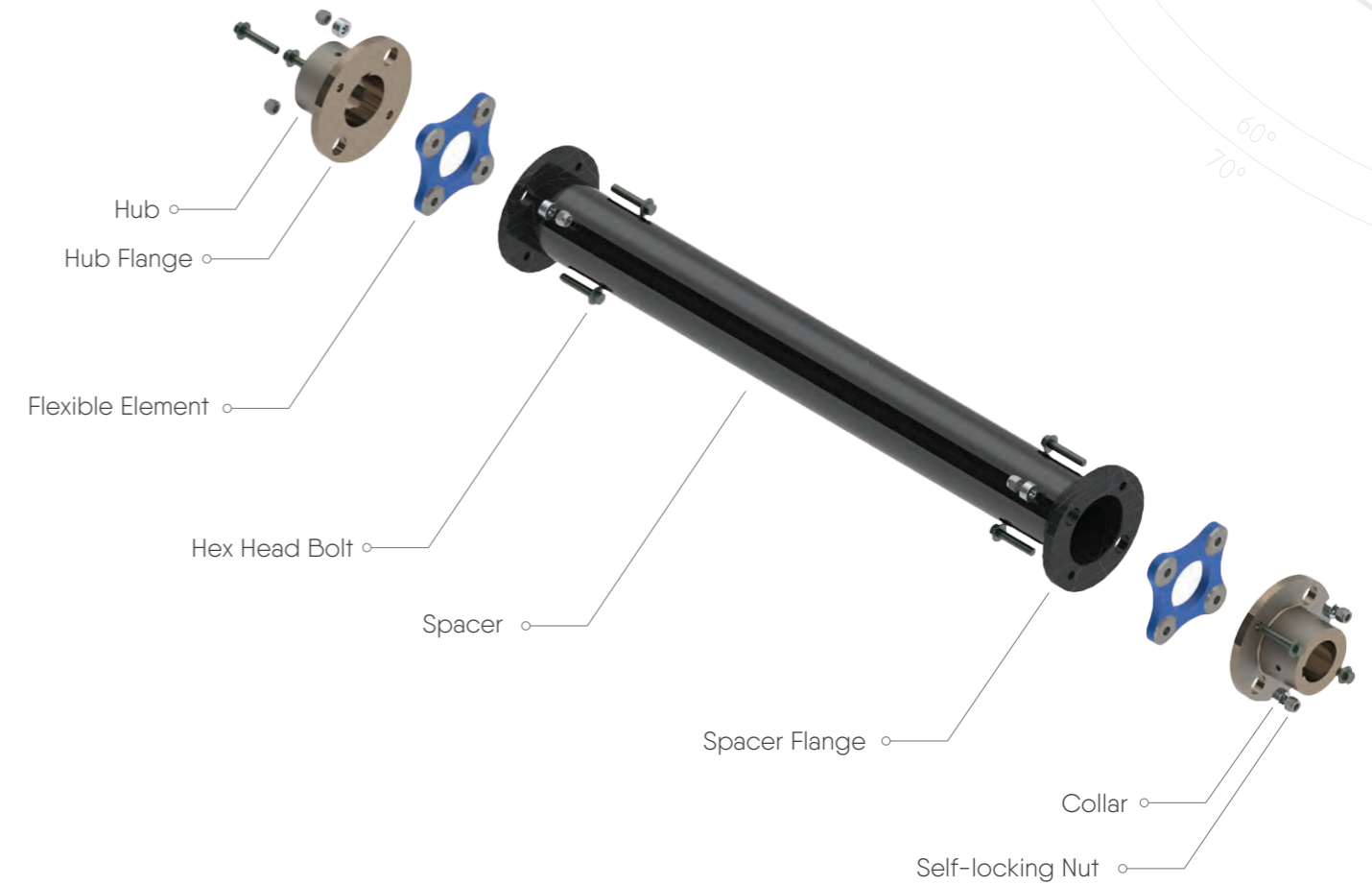

- The hubs, along with the fasteners, are made out of marine grade stainless steel (316) in order to provide increased protection against corrosion in aggressive environments.
- The floating spacer is built from carbon or glass (e-glass) fibres. This composite material is ingrained into an epoxy matrix. A carbon black additive is supplemented to the epoxy resin to provide ultra violet protection.
- The flexible elements are made from advanced high-strength composite disc-links and steel bushings, encapsulated in polyurethane. The combination of links and bushings into an aggregated single flexible element provides for improved handling and installation. Unitized elements also eliminates the risk of fretting corrosion. The high strength of the composite material ensures an extended life of the assembly at rated torque and misalignment values. The links come in 5 different sizes (for power ranging 75kW to 675 kW) and can accommodate for 1° misalignment per flexible element.
- The spacer flange is entirely made out of composite material and its interface with the spacer has been developed to maximize the longevity of the coupling. Poor design of this interface is indeed a common cause for failure of composite couplings. During the ESCOFIL DFCT design and testing phase, ESCO put a special focus in optimizing the spacer-flange interface.

ESCODISC FIL series

DFCT

How to select the right coupling

Coupling size selection

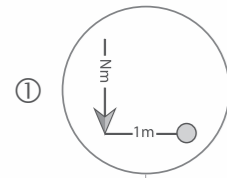

Select the size of ESCOFIL coupling that has the required torque capacity by comparing the figure in TABLE 2, Col. 2 (Max. continues Torque) with the figure obtained through to the following formula: $T(Nm) = 9550 * P * Fu / N$, with:

- P, power in Kw
- N, speed in rpm
- Fu, safety factor, (dependant on the application, usually 2 for cooling tower applications)

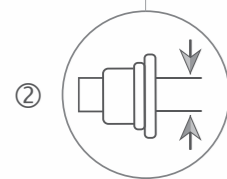

Make sure this coupling will accommodate the largest shaft diameter (see Technical Data TABLE 1 (General Dimensions), Col. 1 (Coupling size) & 2 (Max. Bore).

The coupling selected following ② must have an equal or greater torque capacity than the Torque figure provided by equation ①. Should it not be the case, please select a coupling of a larger size from TABLE 1.

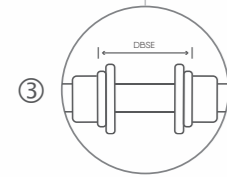

For the selected coupling size, identify in TABLE 1 the first spacer shaft type for which maximum Shaft End Separation (SES, TABLE 1, Col. 10 (Max SES)) exceeds the required SES for the application (often referred to as DBSE, distance between shaft ends). The coupling model will be designated by the combination of its max diameter and shaft type (e.g. 73 M3).

Example:

Motor Power: 50kW
 Motor Speed: 1500rpm
 Service Factor: 2 (for Cooling Tower)

$$T = 9550 * 50 * 2 / 1500 = 764Nm$$

In TABLE 2, Col. 2 (Max. continues Torque), compare the obtained value 764 to the maximum continues torque ratings to find the first size that equals or exceeds this value. In this case the selection is 73.



Assembly weight

The weight of the total assembly is the sum of the shaft weight at minimum SES and the weight of the remaining length of the shaft.

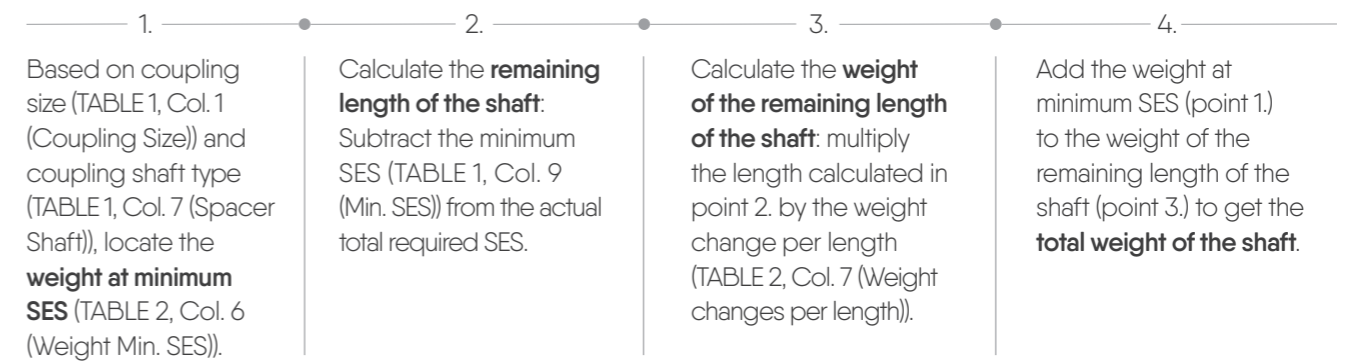

Assembly Inertia

Apply the same method then for the calculation of the weight of the assembly but use the inertia at minimum SES (TABLE 2, Col. 8 (Wr² @ Min. SES)) and the inertia changes per length (TABLE 2, Col. 9 (Wr² Change per Length)) instead of the weight (changes).

Floating spacer shaft critical speed

The critical speed of the floating spacer shaft can be determined from the chart below. Once you know the spacer shaft designation (i.e. L4) and the SES you can plot the point on the chart to determine the critical speed. For example, if the SES is 3 m and spacer shaft is L4 find the intersection of x axis at 3 m with the curve of L4 and read the critical speed on the y axis. In this example the value is 3100 cycles per minutes.

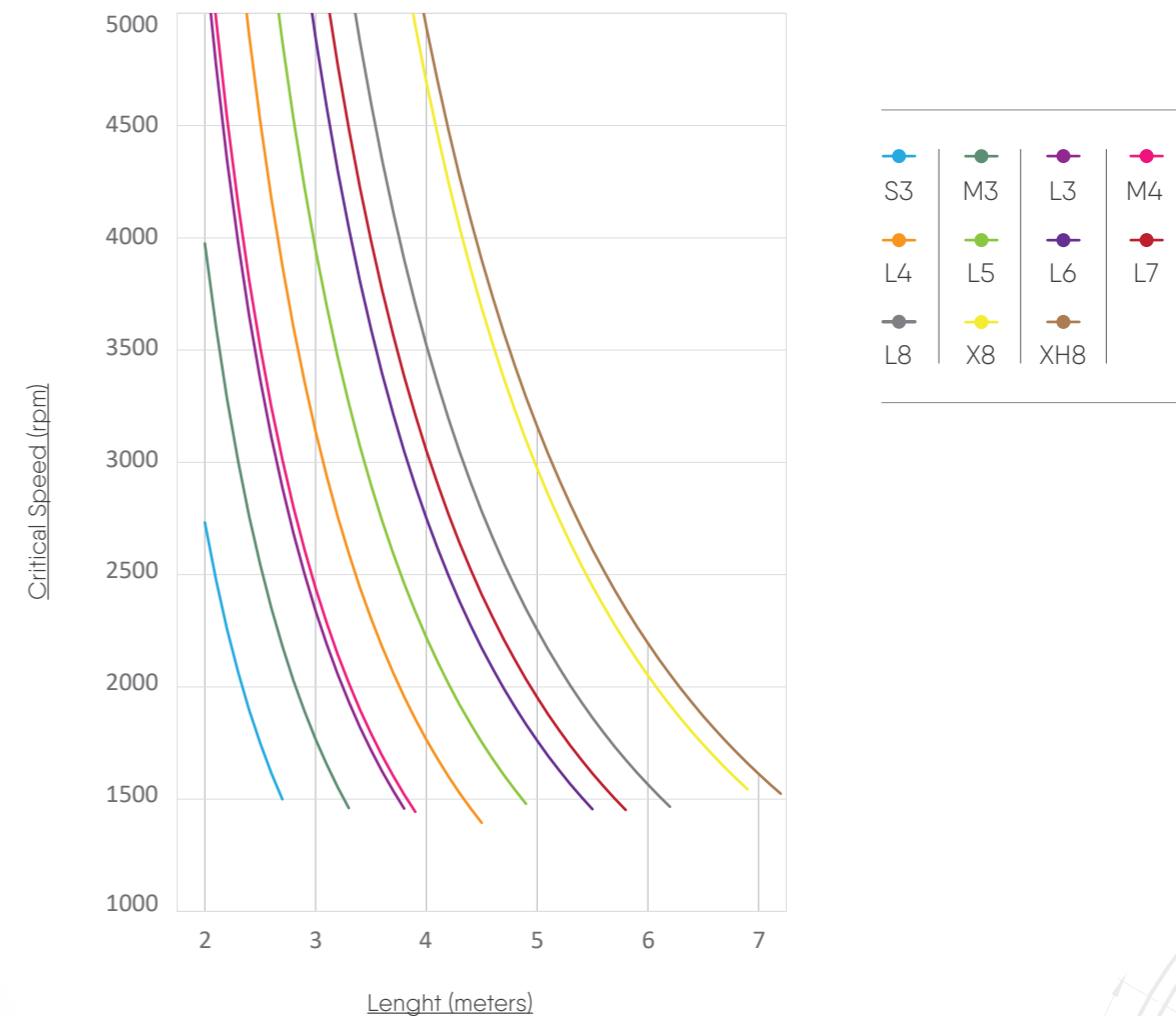

To be in line with guidelines of Cooling Tower Technology Institute, add an additional safety factor of 1.3 to determine the critical speed.

ESCODISC FIL series

DFCT

Technical data

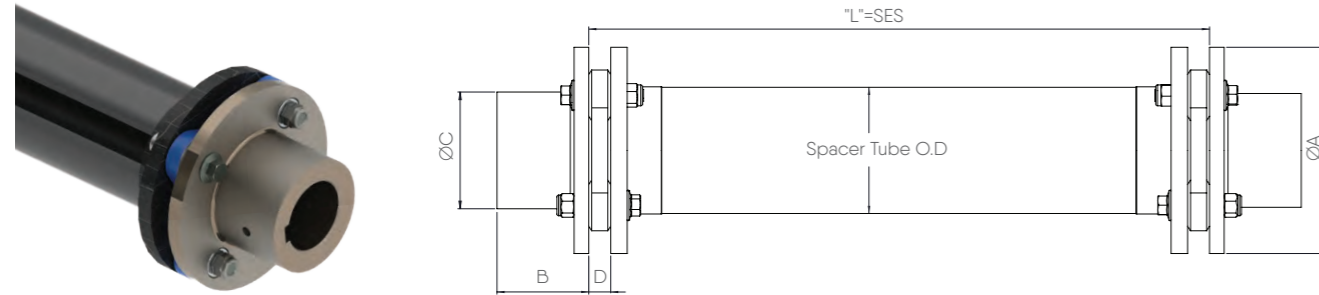

Coupling Size	Max. Bore	A	B	C	D	Spacer Shaft	Spacer Tube O.D	Min. SES L	Maximum SES @1800/1500 rpm ¹
E75	54 (2.12)	133.35 (5.25)	57.15 (2.25)	74.4 (2.93)	12.7 (0.5)	S3	81 (3.2)	229 (9)	2050 (80)/2330 (92)
E75	54 (2.12)	133.35 (5.25)	57.15 (2.25)	74.4 (2.93)	12.7 (0.5)	M3	81 (3.2)	229 (9)	2540 (100)/2794 (110)
E150	73 (2.87)	133.35 (5.25)	57.15 (2.25)	74.4 (2.93)	12.7 (0.5)	S3	81 (3.2)	229 (9)	2050 (80)/2330 (92)
E150	73 (2.87)	133.35 (5.25)	57.15 (2.25)	74.4 (2.93)	12.7 (0.5)	M3	81 (3.2)	229 (9)	2540 (100)/2794 (110)
E150	73 (2.87)	133.35 (5.25)	57.15 (2.25)	74.4 (2.93)	12.7 (0.5)	L3	81 (3.2)	229 (9)	2870 (113)/3125 (125)
E225	101 (4)	178.56 (7.03)	79.5 (3.13)	98.55 (3.88)	16 (0.63)	M4	108 (4.25)	305 (12)	3022 (119)/3327 (131)
E225	101 (4)	178.56 (7.03)	79.5 (3.13)	98.55 (3.88)	16 (0.63)	L4	108 (4.25)	305 (12)	3454 (136)/3784 (149)
E225	101 (4)	178.56 (7.03)	79.5 (3.13)	98.55 (3.88)	16 (0.63)	L5	135 (5.31)	305 (12)	3886 (153)/4267 (168)
E225	101 (4)	178.56 (7.03)	79.5 (3.13)	98.55 (3.88)	16 (0.63)	L6	160 (6.28)	305 (12)	4267 (168)/4673 (184)
E300	101 (4)	178.56 (7.03)	79.5 (3.13)	111.25 (4.38)	19 (0.75)	L4	108 (4.25)	305 (12)	3454 (136)/3784 (149)
E300	101 (4)	178.56 (7.03)	79.5 (3.13)	111.25 (4.38)	19 (0.75)	L5	135 (5.31)	305 (12)	3886 (153)/4267 (168)
E300	101 (4)	178.56 (7.03)	79.5 (3.13)	111.25 (4.38)	19 (0.75)	L6	160 (6.28)	305 (12)	4267 (168)/4673 (184)
E675	106 (4.19)	241.3 (9.50)	95.25 (3.75)	139.7 (5.50)	19 (0.75)	L6	160 (6.28)	356 (14)	4267 (168)/4673 (184)
E675	106 (4.19)	241.3 (9.50)	95.25 (3.75)	139.7 (5.50)	19 (0.75)	L7	186 (7.3)	356 (14)	4597 (181)/5029 (198)
E675	106 (4.19)	241.3 (9.50)	95.25 (3.75)	139.7 (5.50)	19 (0.75)	L8	211 (8.3)	356 (14)	4902 (193)/5359 (211)
E675	106 (4.19)	241.3 (9.50)	95.25 (3.75)	139.7 (5.50)	19 (0.75)	X8	211 (8.3)	356 (14)	5384 (212)/5892 (232)
E675	106 (4.19)	241.3 (9.50)	95.25 (3.75)	139.7 (5.50)	19 (0.75)	XH8	211 (8.3)	356 (14)	5740 (226)/6299 (248)

¹ Maximum S.E.S. is defined based on a 1.3 minimum critical speed safety factor, following Cooling Technology Institute, chapter 10 specifications.

ESCODISC FIL series

DFCT

Coupling Size	Max. continues Torque Nm (lb-in) @ 1.0 sf	Peak Overload Torque Nm (Lb-in)	Axial capacity per END mm (in)	Spacer Shaft	Weight @ Min. SES Kg (Lb)	Weight changes per length (Kg/m) (lb/in)	Wr ² @ Min.SES Kg-m ² (lb-in ²)	Wr ² Change per Length Kg-m ² (lb-in ²)
E75	400 (3540)	800 (7080)	0.75 (0.03)	S3	5.9 (13.1)	1.875 (0.105)	0.010 (35)	0.0025 (0.218)
E75	400 (3540)	800 (7080)	0.75 (0.03)	M3	5.89 (13)	1.58 (0.089)	0.010 (35)	0.0021 (0.185)
E150	800 (7080)	1625 (14382)	0.75 (0.03)	S3	5.26 (11.6)	1.875 (0.105)	0.009 (33)	0.0025 (0.218)
E150	800 (7080)	1625 (14382)	0.75 (0.03)	M3	5.2 (11.5)	1.58 (0.089)	0.009 (33)	0.0021 (0.185)
E150	800 (7080)	1625 (14382)	0.75 (0.03)	L3	5.12 (11.3)	1.125 (0.063)	0.009 (32)	0.0015 (0.131)
E225	1220 (10800)	2440 (21600)	1 (0.04)	M4	142 (31.4)	2.75 (0.154)	0.0392 (134)	0.0076 (0.666)
E225	1220 (10800)	2440 (21600)	1 (0.04)	L4	14 (31)	1.96 (0.11)	0.0386 (132)	0.0054 (0.472)
E225	1220 (10800)	2440 (21600)	1 (0.04)	L5	16.2 (35.7)	2.4 (0.136)	0.0474 (162)	0.010 (0.902)
E225	1220 (10800)	2440 (21600)	1 (0.04)	L6	18.8 (41.6)	2.9 (0.162)	0.0626 (214)	0.017 (1.536)
E300	1625 (14385)	3250 (28764)	1 (0.04)	L4	16.2 (35.8)	1.96 (0.11)	0.0386 (132)	0.0054 (0.472)
E300	1625 (14385)	3250 (28764)	1 (0.04)	L5	18.4 (40.5)	2.4 (0.136)	0.0474 (162)	0.010 (0.902)
E300	1625 (14385)	3250 (28764)	1 (0.04)	L6	20.9 (46.2)	2.9 (0.162)	0.0626 (214)	0.017 (1.536)
E675	3672 (32500)	7344 (65000)	1.25 (0.05)	L6	31.5 (69.5)	2.9 (0.162)	0.18 (630)	0.017 (1.536)
E675	3672 (32500)	7344 (65000)	1.25 (0.05)	L7	35.3 (77.8)	3.37 (0.189)	0.21 (735)	0.027 (2.413)
E675	3672 (32500)	7344 (65000)	1.25 (0.05)	L8	39.6 (87.4)	3.8 (0.215)	0.26 (896)	0.041 (3.573)
E675	3672 (32500)	7344 (65000)	1.25 (0.05)	X8	39.6 (87.4)	3.8 (0.215)	0.26 (896)	0.041 (3.573)
E675	3672 (32500)	7344 (65000)	1.25 (0.05)	XH8	39.6 (87.4)	3.8 (0.215)	0.26 (896)	0.041 (3.573)

All couplings are dynamically balanced to meet ISO 1940/1 G6.3 grade specifications.

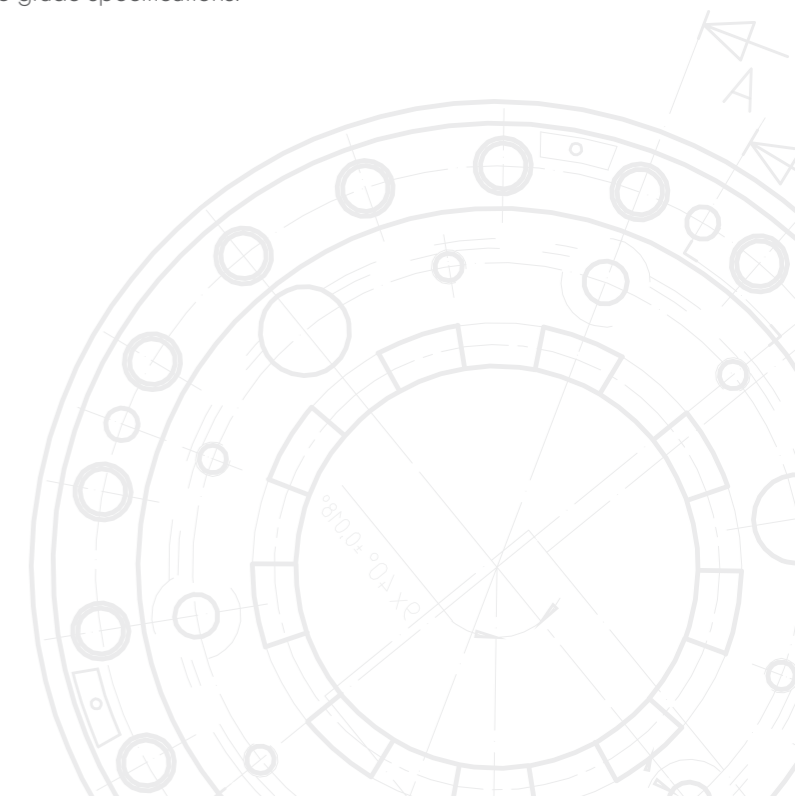

ESCODISC FIL series

DFCT

Application data sheet

Motor parameters	
Motor horsepower (kW):	
Motor speed (rpm):	
Motor type:	
Motor shaft diameter (mm):	
Motor shaft keyway size:	

Gearbox parameters	
Gearbox ratio:	
Gearbox input shaft diameter (mm):	
Gearbox shaft keyway size:	
Gearbox type:	

Fan parameters	
Fan speed (rpm):	
Fan number of blades:	

Application parameters	
Application type:	
Application Service Factor:	

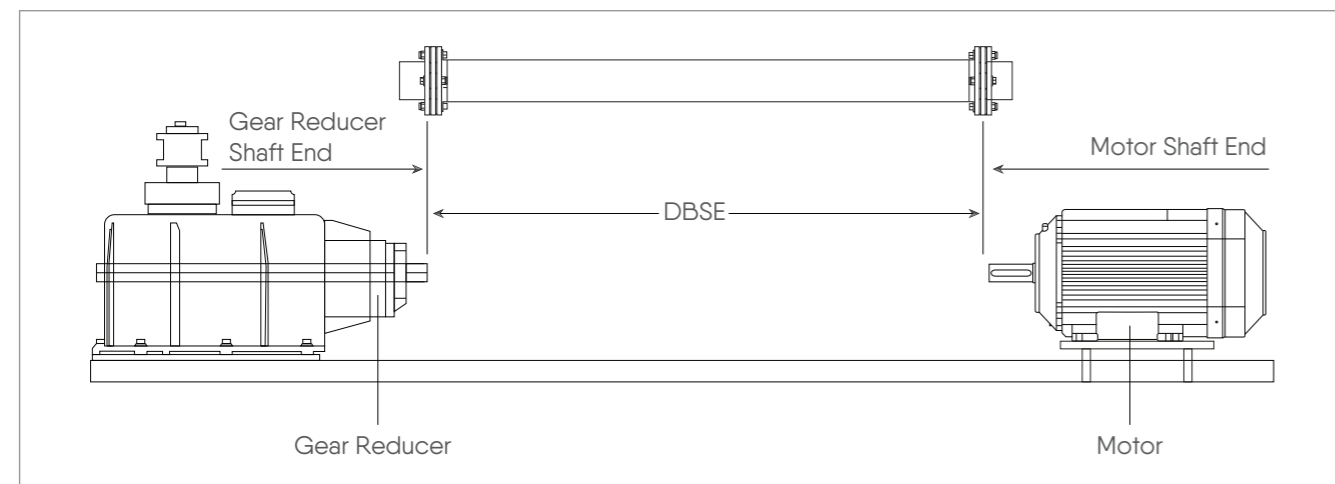

ESCODISC FIL series

DFCT

Equivalence chart based on torque ratings and maximum bore

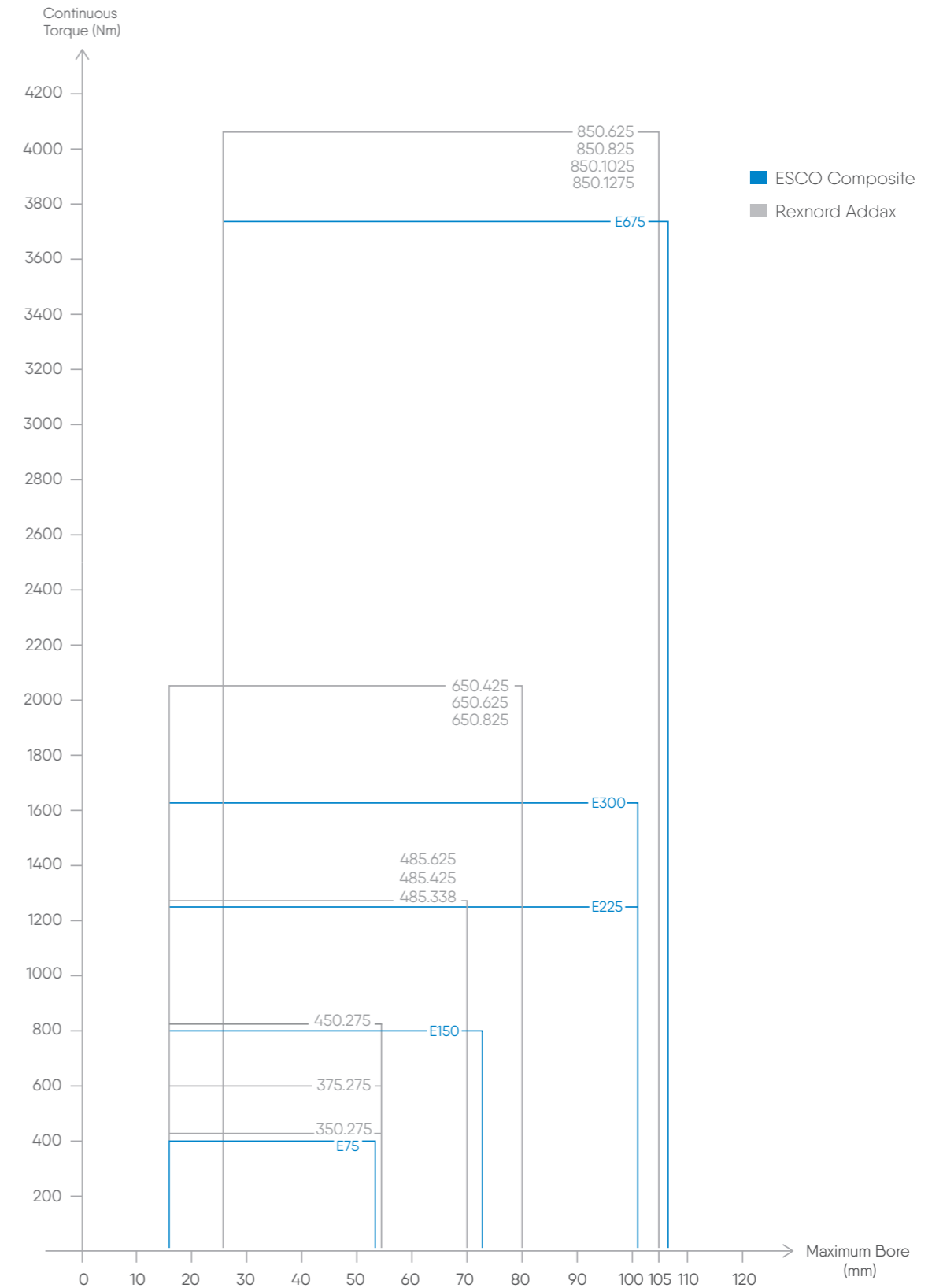

The equivalence chart provides a quick indication about which DFCT coupling may suit your needs. It does however not replace a proper selection process. Please contact ESCO for more information on selecting the best coupling for your application.

Much more than products

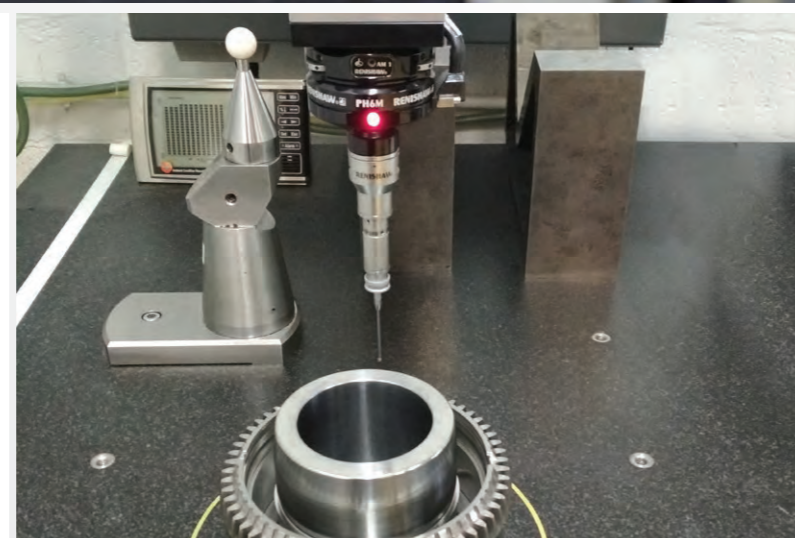
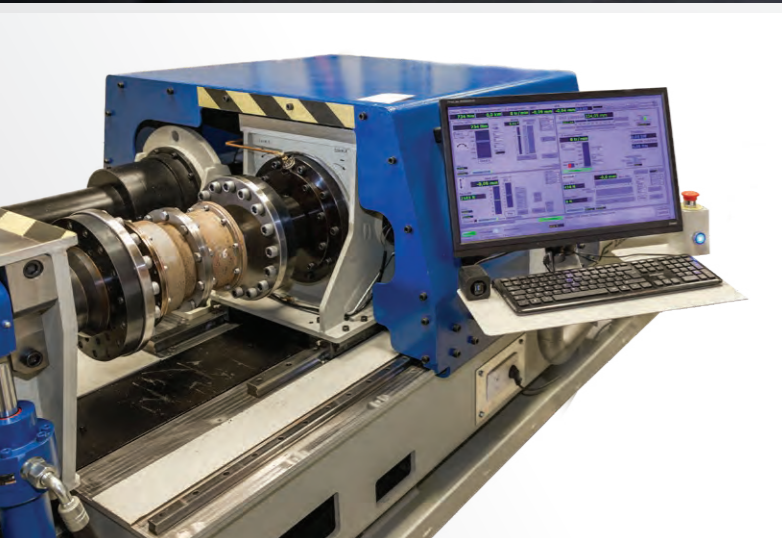
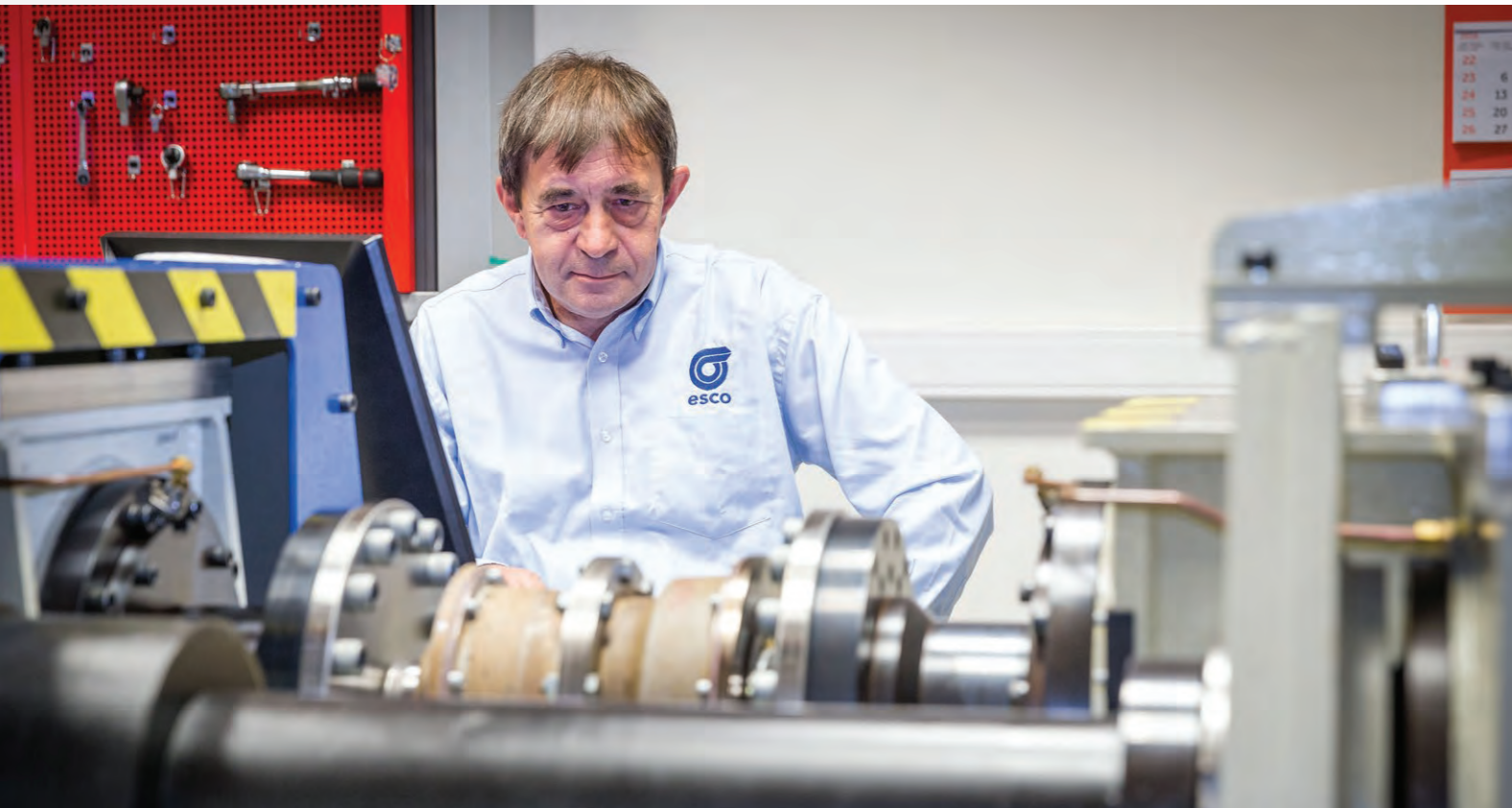

Our relationship with customers does not stop once couplings are delivered. We have a team of experienced people ready to perform service on the field, repair, inspections, testing... We can also do the maintenance on our couplings for you. This guarantees proper execution of the maintenance instructions and contributes to improving the lifetime of your application.

We have spent the last 50 years building our expertise. Our engineering team is equipped to design and test a wide range of coupling solutions. Please contact us, we will design the right coupling for your application.



Once we get involved into a specific sector, we make sure to embrace the quality standards that the market requires. This is why, we are ISO 9001 certified.

A global footprint, with a family of 9 companies located all across the world



9 offices across the world | **4** manufacturing sites

- ESCO Couplings N.V.
Diegem, Belgium
- ESCO Couplings & Transmissions Pvt. Ltd.
Bengaluru, India
- ESCO Couplings Ltd.
Jinan, China
- André De Decker & Fils S.A.
Saintes, Belgium
- ESCO Power N.V.
Saintes, Belgium

- Head-office & Manufacturing site
- Manufacturing sites
- Sales offices & Service centres

- ESCO Aandrijvingen B.V.
Alphen A/D Rijn,
The Netherlands
- ESCO Antriebstechnik GmbH
Troisdorf, Germany
- ESCO Drives N.V.
Diegem, Belgium
- ESCO Transmissions SAS.
Saint Witz, France

Catalogues and brochures

Industry brochures



Corporate brochure



Railway applications



Marine applications



General industry applications



Metals and mining applications



Wind applications

Catalogues



General program



Product catalogue



ESCOGEAR F series



ESCOGEAR N series



ESCODISC DLC / DMU / DPU series



ESCOGEAR C & C..M series



ESCODISC FIL SERIES



ESCOFLEX & ESCONYL series

ESCO worldwide

ESCO Couplings N.V.
 Culliganlaan, 3
 B - 1831 Diegem
 Belgium
 Tel +32 (0) 2 715 65 60
 Fax +32 (0) 2 720 83 62
 e-mail: info@esco-couplings.be
 website: www.esco-group.com

ESCO Aandrijvingen B.V.
 Ondernemingsweg, 19
 NL - 2404 HM Alphen A/D Rijn
 The Netherlands
 Tel +31 (0) 172 42 33 33
 Fax +31 (0) 172 42 33 42
 e-mail: info@esco-aandrijvingen.nl
 website: www.esco-aandrijvingen.nl

André De Decker & Fils S.A.
 Avenue Ernest Solvay, 48
 B - 1480 Saintes
 Belgium
 Tel +32 (0) 2 355 10 70
 Fax +32 (0) 2 355 10 71
 e-mail: info@adedecker.com
 website: www.adedecker.com

ESCO Drives N.V.
 Culliganlaan, 3
 B - 1831 Diegem
 Belgium
 Tel +32 (0) 2 717 64 60
 Fax +32 (0) 2 717 64 61
 e-mail: info@esco.be
 website: www.esco.be

ESCO Antriebstechnik GmbH
 Biberweg 10
 D - 53842 Troisdorf
 Germany
 Tel +49 (0) 2241 4807 0
 Fax +49 (0) 2241 4807 10
 e-mail: info@esco-antriebstechnik.com
 website: www.esco-antriebstechnik.de











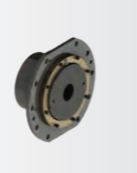

ESCO Transmissions SAS
 Rue de la Ferme Saint-Ladre, 34
 F - 95471 Saint-Witz
 France
 Tel +33 (0) 1 34 31 95 95
 Fax +33 (0) 1 34 31 95 99
 e-mail: info@esco-transmissions.fr
 website: www.esco-transmissions.fr

ESCO Power N.V.
 Avenue Ernest Solvay, 48
 B - 1480 Saintes
 Belgium
 Tel + 32 (0) 2 717 64 90
 Fax + 32 (0) 2 717 64 91
 e-mail: info@escopower.be
 website: www.escopower.be









ESCO Couplings Ltd.
 2168 Airport Road
 CN - 250107 Jinan
 China
 Tel +86 531 55711596
 Fax +86 531 55711599
 e-mail: info@esco-couplings.cn
 website: www.esco-group.com

ESCO Couplings & Transmissions Pvt. Ltd.
 Plot No. 69-D
 Bengaluru Aerospace Park
 Unachuru Village Jala Hobli
 Bengaluru
 India
 Tel +91 80 7100 1800
 e-mail: info@esco-couplings.co.in
 website: www.esco-group.com

ESCO couplings product range

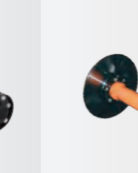
							
Product Line		F/C/N	D	Flex	Nyl	FWD	FET
Product Technology/Type		Gear	Disc	Elastic	Elastic	Gear (Barrel Equivalent)	Gear (with Torque Limiter)
	General Industry	⊙	⊙	⊙	⊙	⊙	⊙
	Metals & Mining	⊙	⊙	⊙	⊙	⊙	⊙
	Crane & Hoisting	⊙	⊙			⊙	⊙
	Power Generation	⊙	⊙				
	Oil & Gas	⊙	⊙				⊙
	Marine	⊙	⊙				
	Cooling Towers						
	Railway - High-speed, Intercity, Metro						
	Railway - Tram		⊙				
	Wind Power Generation	⊙	⊙				

*Available with torque limiter

								
Grid	FTRN*	(D)FTRN(FS)*	High Speed	High Speed	FWMO*	DWMO*	Composite	Service
Grid	Gear	Gear/Disc	Gear	Disc	Gear	Disc	Composite	Engineering, Repair, Maintenance
⊙							⊙	⊙
⊙							⊙	⊙
⊙								⊙
			⊙	⊙			⊙	⊙
⊙			⊙	⊙			⊙	⊙
							⊙	⊙
	⊙							⊙
	⊙	⊙						⊙
					⊙	⊙		⊙

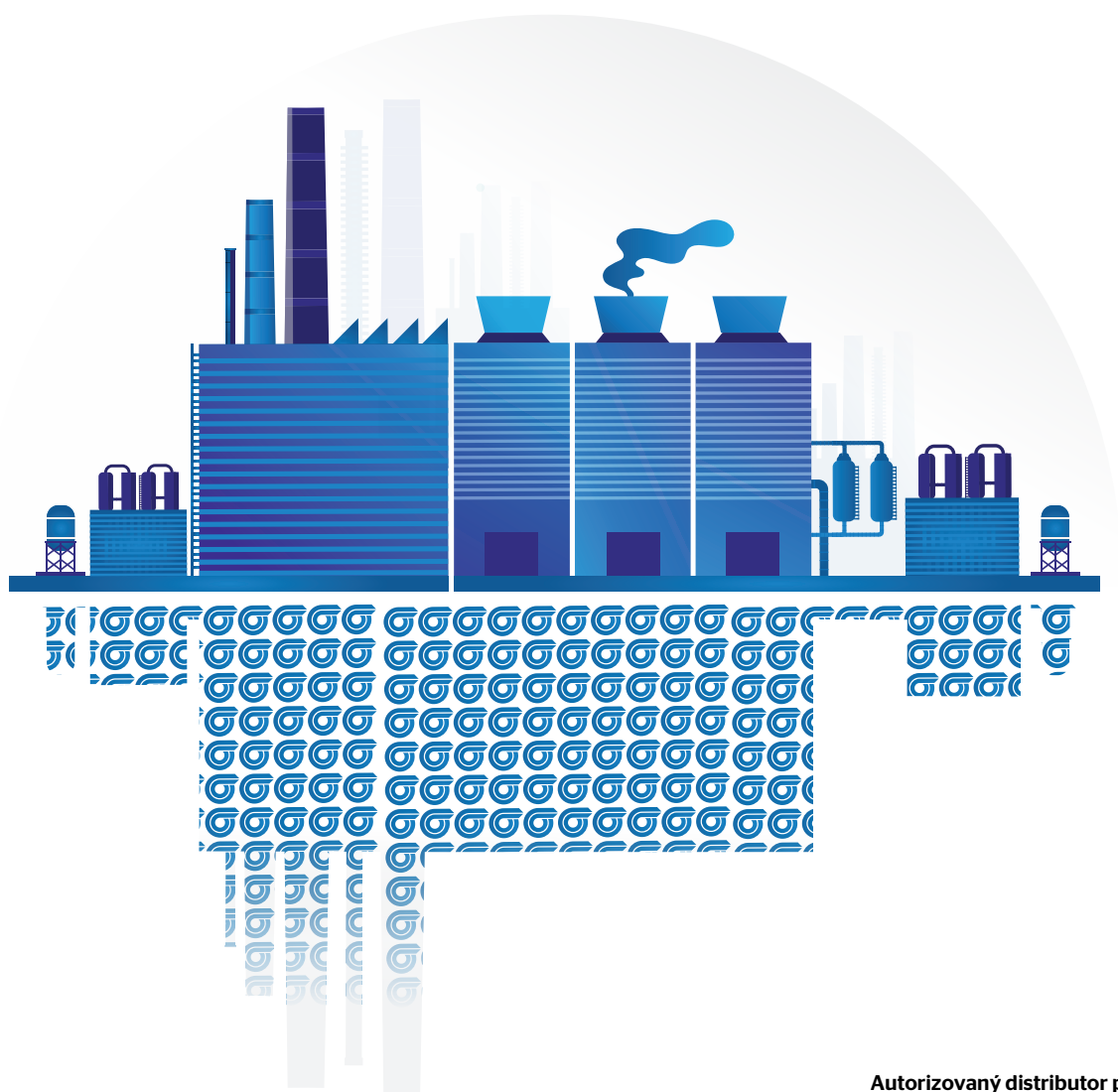

Autorizovaný distributor pro ČR



www.escogroup.com

TYMA CZ, s.r.o.
Na Pískách 731
CZ - 400 04 Trmice
Phone +420 475 655 010
Email info@tyma.cz
www.tyma.cz